



TEST REPORT

Report No.: F8660.01-901-44

Rendered to:

COEUR D'ALENE WINDOW
Spokane Valley, Washington

PRODUCT TYPE: PVC Awning Window
SERIES/MODEL: 3511

SPECIFICATIONS:

AAMA/WDMA/CSA 101/I.S.2/A440-11, *NAFS 2011 - North American Fenestration Standard/Specification for Windows, Doors, and Skylights*

and

AAMA/WDMA/CSA 101/I.S.2/A440-08, *NAFS - North American Fenestration Standard/Specification for Windows, Doors, and Skylights*

and

CSA A440S1-09, Canadian Supplement to AAMA/WDMA/CSA 101/I.S.2/A440, *NAFS - North American Fenestration Standard/Specification for Windows, Doors, and Skylights*

Title	Summary of Results
AAMA/WDMA/CSA 101/I.S.2/A440-08 and -11	Class CW PG55 1200 x 800 (47 x 32) Type AP
Design Pressure	±2640 Pa (55.14 psf)
Air Infiltration	0.86 L/s/m ² (0.17 cfm/ft ²)
Air Exfiltration	0.94 L/s/m ² (0.18 cfm/ft ²)
Canadian Air Infiltration/Exfiltration Level	A2
Water Penetration Resistance Test Pressure	720 Pa (15.04 psf)

Test Completion Date: 08/31/16

Reference must be made to Report No. F8660.01-901-44, dated 11/15/16 for complete test specimen description and detailed test results.

1.0 Report Issued To: Coeur d'Alene Window
3808 N. Sullivan Road
Spokane Valley, WA 99216

2.0 Test Laboratory: Architectural Testing, Inc.,
an Intertek Company (Intertek-ATI)
22155 68th Avenue South
Kent, Washington 98032
253-395-5656

3.0 Project Summary:

3.1 Product Type: PVC Awning Window

3.2 Series/Model: 3511

3.3 Compliance Statement: Results obtained are tested values and were secured by using the designated test method(s). The specimen tested successfully met the performance requirements for the following ratings **Class CW PG55 1200 x 800 (47 x 32) Type AP.**

3.4 Test Dates: 05/11/16 – 08/31/16

3.5 Test Record Retention End Date: All test records for this report will be retained until 08/31/20.

3.6 Test Location: Intertek-ATI test facility in Kent, Washington.

3.7 Test Specimen Source: The test specimen was provided by the client. Representative samples of the test specimen will be retained by Intertek-ATI for a minimum of four years from the test completion date.

3.8 Drawing Reference: The test specimen drawings have been reviewed by Intertek-ATI and are representative of the test specimens reported herein. Test specimen construction was verified by Intertek-ATI per the drawings located in the appropriate Appendix. Any deviations are documented herein or on the drawings.

3.9 List of Official Observers:

<u>Name</u>	<u>Company</u>
Chris Griffin	Roto Frank
Chris Wilson	Intertek-ATI
Guillermo Silva	Intertek-ATI

4.0 Test Specifications:

AAMA/WDMA/CSA 101/I.S.2/A440-11, *NAFS 2011 - North American Fenestration Standard/Specification for Windows, Doors, and Skylights*

and

AAMA/WDMA/CSA 101/I.S.2/A440-08, *NAFS - North American Fenestration Standard/Specification for Windows, Doors, and Skylights*

and

CSA A440S1-09, Canadian Supplement to AAMA/WDMA/CSA 101/I.S.2/A440, *NAFS - North American Fenestration Standard/Specification for Windows, Doors, and Skylights*

5.0 Test Specimen Description:

5.1 Product Sizes:

Overall Area: 0.96 m ² (10.3 ft ²)	Width		Height	
	millimeters	inches	millimeters	inches
Overall size	1200	47-1/4	800	31-1/2
Vent size	1164	45-13/16	763	30

5.2 Frame Construction:

Member	Material	Description
All	PVC	White

	Joinery Type	Detail
All corners	Mitered	Each corner was miter cut and thermally welded

5.3 Vent Construction:

Member	Material	Description
All	PVC	White

	Joinery Type	Detail
All corners	Mitered	Each corner was miter cut and thermally welded

5.0 Test Specimen Description: (Continued)**5.4 Weatherstripping:**

Description	Qty.	Location
6.4 mm (0.25") diam. hollow rubber bulb gasket	1 row	Vent, full perimeter
7.6 mm (0.30") high pile with center fin	1 row	Vent, full perimeter
6.4 mm (0.25") high foam filled bulb gasket	1 row	Frame, head and jambs

5.5 Glazing: *No conclusions of any kind regarding the adequacy or inadequacy of the glass in any glazed test specimen(s) can be made.*

Glass Type (Nominal)	Spacer Type	Interior Lite (Nominal)	Exterior Lite (Nominal)	Glazing Method
19 mm (7/8") IG	Alum.	5 mm (1/8") annealed	5 mm (1/8") annealed	Glazed with 3/8" foam glazing tape and PVC glazing beads

Location	Quantity	Daylight Opening		Glass Bite (Nominal)
		millimeters	inches	
Vent	1	1052 x 652	41-7/16 x 25-5/8	12 mm (1/2")

5.6 Drainage: No drainage was utilized.

5.7 Hardware:

Description	Qty.	Location
Rotary operator	1	Sill/bottom rail
Single-point lock with gasketed head set	2	Jambs, lock points located approx. 267 mm (10-1/2") from the sill
Plastic keeper	4	Vent stile and head, aligned with lock points and each secured with four #8 by 1/2" screws
Metal compression snubbers (nested pair)	2 pairs	Head/top rail, located approx. 238 mm (9-3/8") from each end and each secured with two #8 by 1/2" screws
Metal structural-compression snubbers (nested pair)	1 pair	Head/top rail, mid-span and secured with two #8 by 1/2" screws
Sliding hinge assembly	2	Jambs/stiles

5.8 Reinforcement: No reinforcement was utilized.

6.0 Installation:

The specimen was installed into a Spruce-Pine-Fir wood buck. The rough opening allowed for shim space. The exterior perimeter of the window was sealed with sealant.

Location	Anchor Description	Anchor Location
Full perimeter	#8 by 2" screws	Through the frame approx. no closer than 100 mm (4") from each corner then spaced approx. 108 mm (4-1/4") apart through pre-punched nail slots

7.0 Test Results: The temperature during testing was approx. 26°C (79°F). The results are tabulated as follows:

Title of Test	Results	Allowed	Note
Operating Force, per ASTM E 2068	Initiate motion: 15 N (3.3 lbf) max. Maintain motion: 8 N (1.9 lbf) max. Latches: 13 N (3.0 lbf)	Report Only 45 N (10.12 lbf) max. 100 N (22.48 lbf) max.	
Canadian Operating Force, per ASTM E 2068, Normal Use	Initiate motion: 15 N (3.3 lbf) max. Maintain motion: 8 N (1.9 lbf)	60 N (13.49 lbf) max. 30 N (6.74 lbf) max.	
Air Leakage, Infiltration per ASTM E 283 at 75 Pa (1.57 psf)	0.86 L/s/m ² (0.17 cfm/ft ²)	1.5 L/s/m ² (0.3 cfm/ft ²) max.	1
Air Leakage, Exfiltration per ASTM E 283 at 75 Pa (1.57 psf)	0.94 L/s/m ² (0.18 cfm/ft ²)	0.5 L/s/m ² (0.3 cfm/ft ²) max	1
Canadian Air Infiltration/Exfiltration Level	A2	1.5 L/s/m ² (0.3 cfm/ft ²) max.	
Water Penetration	N/A	N/A	2
Uniform Load Deflection	N/A	N/A	2
Uniform Load Structural	N/A	N/A	2
Forced Entry Resistance, per ASTM F 588 – Grade 20	Pass	No entry	
Forced Entry Resistance per CAWM 301	Pass	No entry	

7.0 Test Results: (Continued)

Title of Test	Results	Allowed	Note
Thermoplastic Corner Weld	Pass	Meets as stated	
Awning/Projected Hardware Load Test 140 N (31.47 lbf)	10.2 mm (0.08")	34.0 mm (1.34") max.	
Optional Performance			
Water Penetration, per ASTM E 547 at 720 Pa (15.04 psf)	Pass	No leakage	
Uniform Load Deflection, per ASTM E 330 taken at top rail between snubbers +2640 Pa (55.14 psf) -2640 Pa (55.14 psf)	0.3 mm (0.02") <0.25 mm (<0.01")	3.31 mm (0.13") max. 3.31 mm (0.13") max.	3, 4
Uniform Load Structural, per ASTM E 330 taken at top rail between snubbers +3960 Pa (82.71 psf) -3960 Pa (82.71 psf)	<0.25 mm (<0.01") <0.25 mm (<0.01")	1.74 mm (0.08") max. 1.74 mm (0.08") max.	3, 4

Note 1: The tested specimen meets (or exceeds) the performance levels specified in AAMA/WDMA/CSA 101/I.S.2/A440 for air leakage resistance.

Note 2: The client opted to start at a pressure higher than the minimum required. Test results are reported under Optional Performance.

Note 3: Loads were held for 10 seconds.

Note 4: Tape and film were used to seal against air leakage during structural testing. In our opinion, the tape and film did not influence the results of the test.

Intertek-ATI will service this report for the entire test record retention period. Test records, such as detailed drawings, datasheets, representative samples of test specimens, or other pertinent project documentation, will be retained by Intertek-ATI for the entire test record retention period.

This report does not constitute certification of this product nor an opinion or endorsement by this laboratory. It is the exclusive property of the client so named herein and relates only to the specimen tested. This report may not be reproduced, except in full, without the written approval of Intertek-ATI.

For INTERTEK-ATI:

Guillermo E. Silva
Technician

Jeffrey L. Dideon
Regional Manager

JLD:pac

Attachments (pages): This report is complete only when all attachments listed are included.

Appendix-A: Alteration Addendum (1)

Appendix-B: Location of Air Seal (1)

Appendix-C: Drawings (5)

Appendix A
Alteration Addendum

Note: No alterations were required.

Appendix B

Location of Air Seal: The air seal between the test specimen and the test wall is detailed below. The seal is made of foam weatherstripping and is attached to the edge of the test specimen buck. The test specimen buck is placed against the test wall and clamped in place, compressing the weatherstripping and creating a seal.

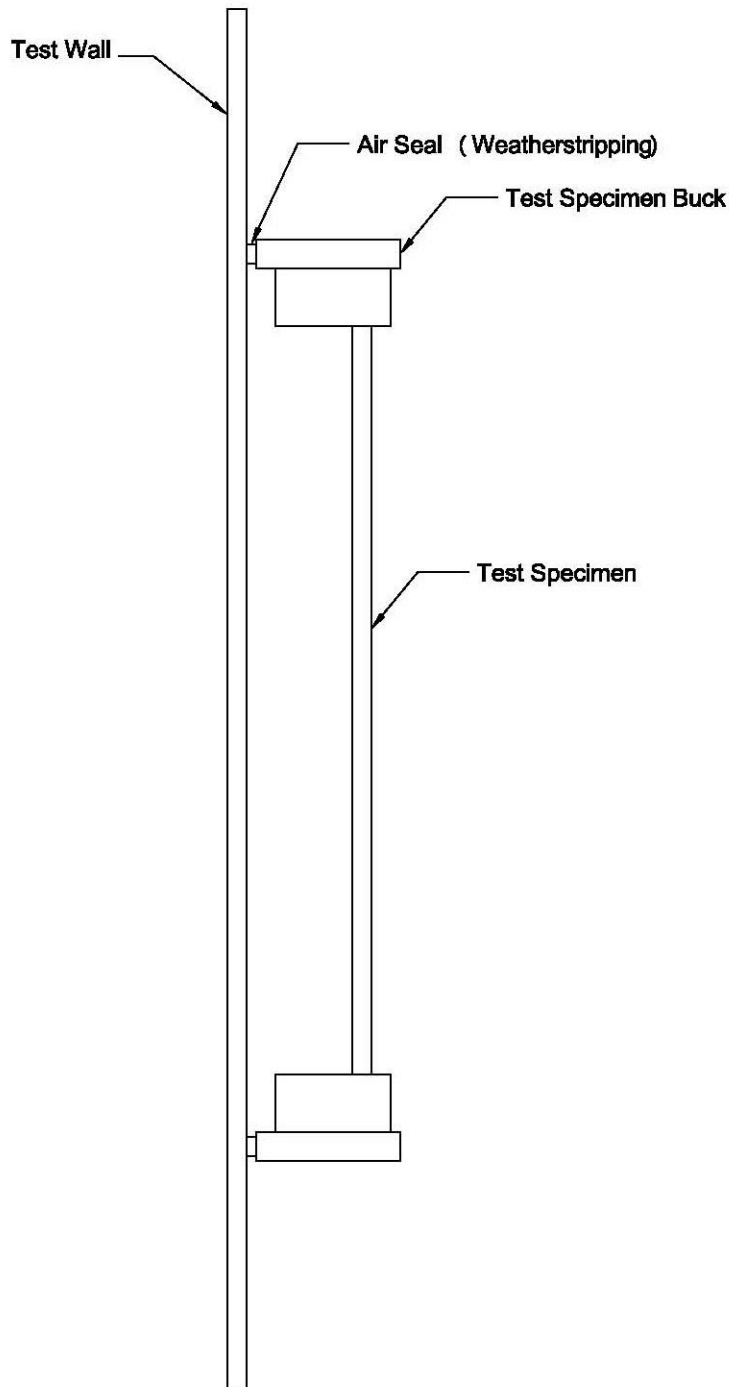

Appendix C

Drawings

3511 Awning

Part	Part #
Casment Main Frame	KE2010
Casement Sash	KE2011
Glazing Bead	KE1994
Setting Block	6152
Setting Block Glue	IPS-56-1021
Glazing Tape	VG1216W-FC515
Handle/Cover Kit	OP08-7900-00
Sash Bracket Assy	OP05-8000
Track Assy (13" facemount)	OP05-8100
Dual Arm Operator	OP08-7504
14" Hinge Arm Podwer LH	HG06-7554
14" Hinge Arm Podwer RH	HG06-7555
14" Hinge Track H SS Left Hand	HG06-7564
14" Hinge Track H SS Right Hand	HG06-7565
Lock Handle	LH18-7524-00
8-32x1/2" Trilobe Truss Head Screw	M13026
Plastic Handle Plate	G2-HNDLPLT-03
Lock Bar Assy 47.9" 4 Pin	LB10-7512
G5 Guide Housing 1005	LB05-1005-29
G6 Nylon Striker 1013	LB06-1013-50
Weather Stripping	E51218KN3020
Weather Stripping	U3532-00000
Weather Stripping	30018745WHGF

 	Report #:	F8660-901-44
	Date:	11/14/16
	Verified by:	

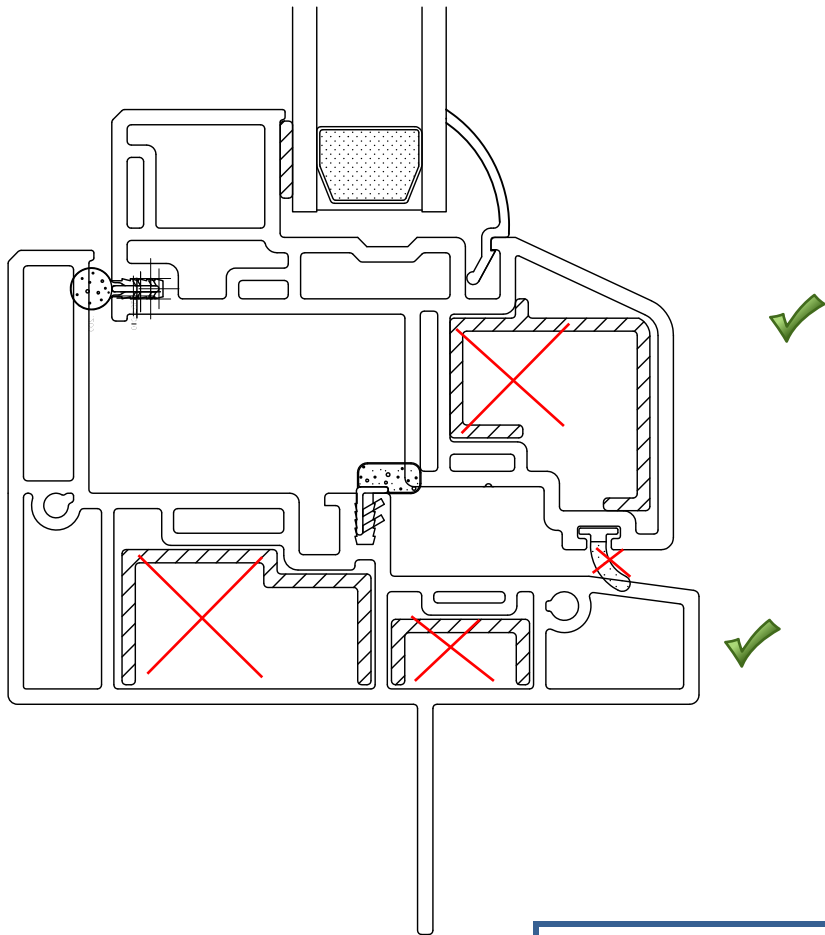

	Report #:	F8660-901-44
	Date:	11/14/16
	Verified by:	<i>[Signature]</i>

CYCLOID DESIGNS 	DWG: 310-L2	DATE: 23-MAY-98	© 1998 COPYRIGHT KING EXTRUSIONS LTD EVERETT, WASHINGTON ALL RIGHTS RESERVED	EXTERNAL WALL: X.XXX INTERNAL WALL: X.XXX CORNER TYP: X.XXXR WEIGHT: X.XXX LB/FT
TITLE: HINGE				

SCALE: 1.5:1

- a=.006R
- b=.012R
- c=.015R
- d=.020R
- e=.030R
- f=.045R
- g=.060R
- s=SHARP

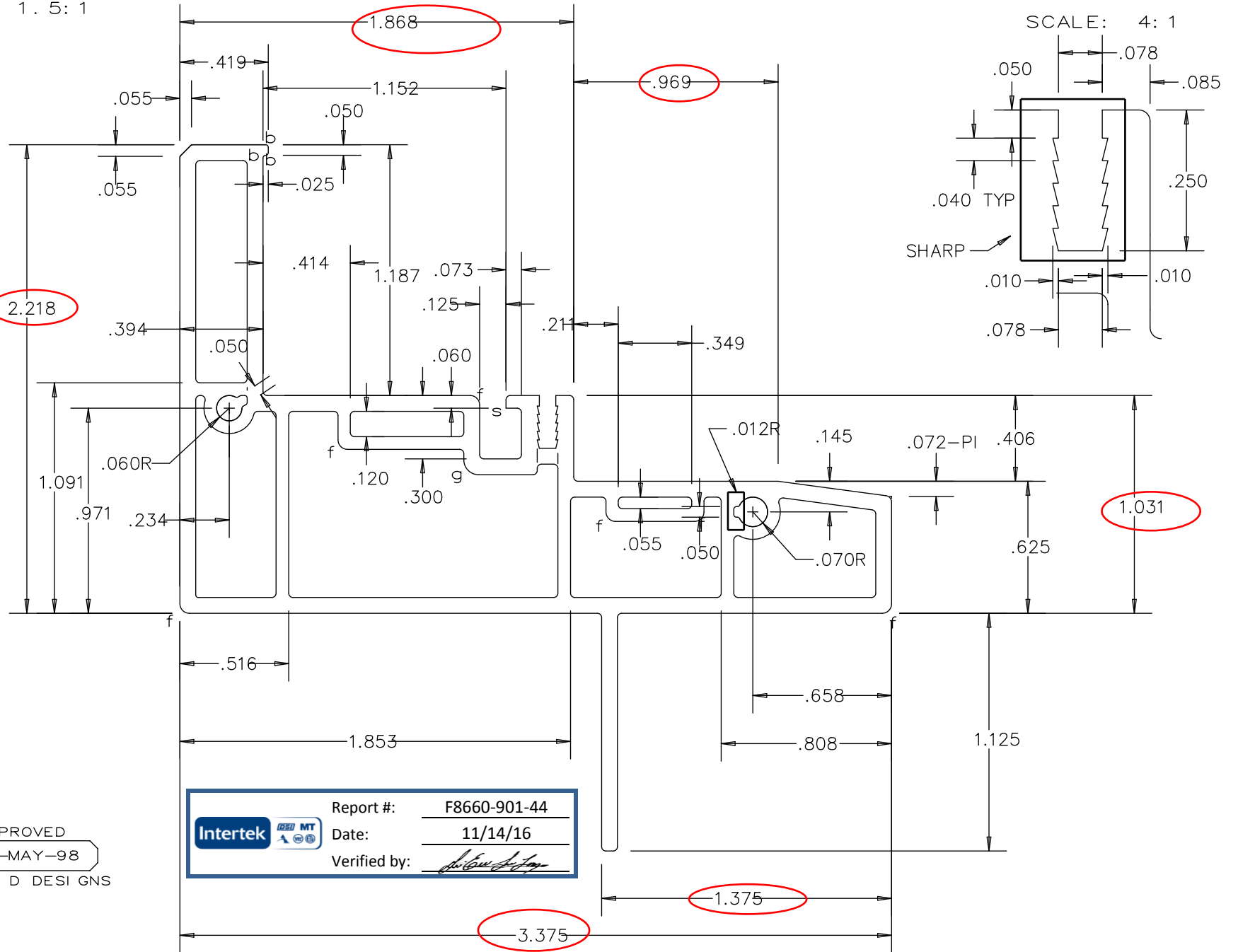

APPROVED
23-MAY-98
CYCLOID DESIGNS

Report #: F8660-901-44
Date: 11/14/16
Verified by: *[Signature]*

CYCLOID DESIGNS	DWG: 310-D1	DATE: 07-MAY-98	© 1998 COPYRIGHT KING EXTRUSIONS LTD EVERETT, WASHINGTON ALL RIGHTS RESERVED	EXTERNAL WALL: 0.075 INTERNAL WALL: 0.060 CORNER TYP: 0.020R WEIGHT: 0.746 LB/FT
TITLE: CASEMENT FRAME		KE2010		

SCALE: 2: 1

- a=0. 006R
- b=0. 012R
- c=0. 015R
- d=0. 020R
- e=0. 030R
- f=0. 045R
- g=0. 060R
- s=SHARP
- h=0. 187R

SCALE: 4: 1

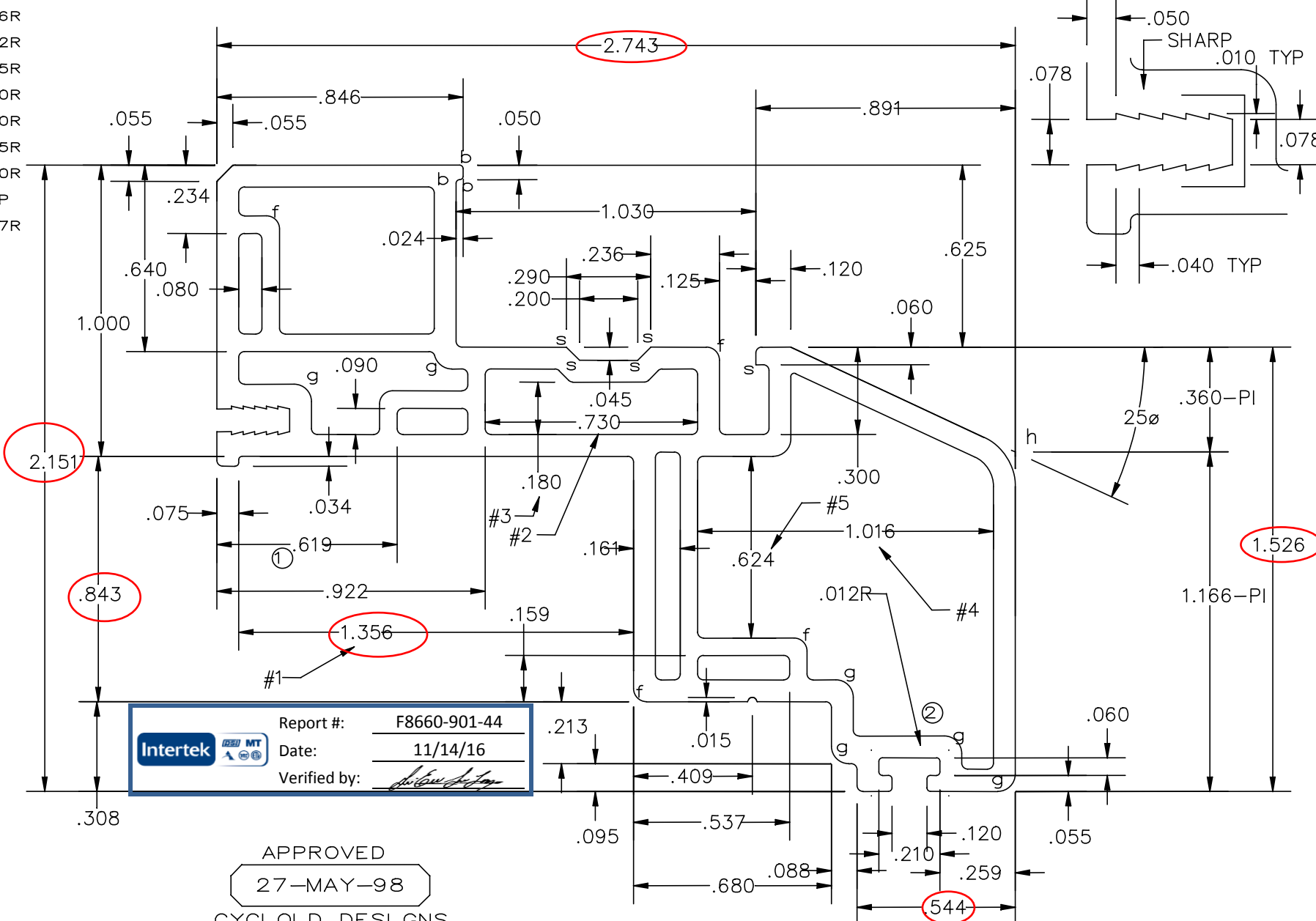

	Report #:	F8660-901-44
	Date:	11/14/16
	Verified by:	<i>[Signature]</i>

APPROVED
27-MAY-98
CYCLOID DESIGNS

2	07-16-98	WALL CORRECTED; WT WAS .599
1	07-16-98	DI MENSION CORRECTED
REV	DATE	REMARKS

CYCLOID DESIGNS DWG: 310-D2 DATE: 23-MAY-98
 TITLE: CASEMENT SASH KE2011

© 1998 COPYRIGHT KING EXTRUSIONS LTD
 EVERETT, WASHINGTON
 ALL RIGHTS RESERVED

EXTERNAL WALL: 0.075
 INTERNAL WALL: 0.060
 CORNER TYP: 0.020R
 WEIGHT: 0.603 LB/FT

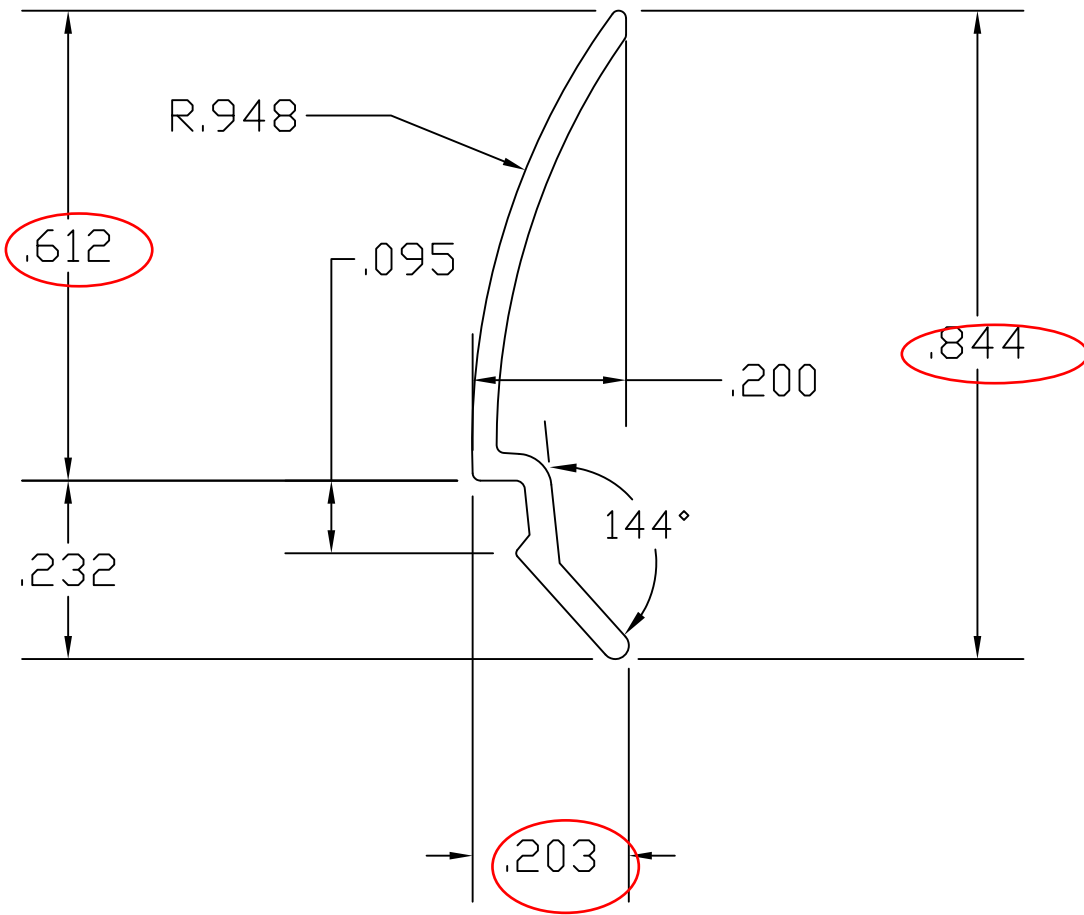

Customer Approval
 By: _____
 Date: _____



 Report #: F8660-901-44
 Date: 11/14/16
 Verified by: *[Signature]*

REV #	DATE	REVISION NOTES

External Walls = .065 Internal Walls = .045	Layout Name: Base	DATE: 4-25-08
	Drawn BY: gmc SCALE: 4:1	ACAD#: R1994 Bead
CUSTOMER: RSE	PROJECT: Sierra Classic SlimLine	AREA = .0323 WT/FT = .020
TITLE: Clam Shell Bead		

Copyright © 2008
ROYAL GROUP, INC.

100A Royal Group Crescent
 Woodbridge, Ontario
 Canada L4L 8Z7
 All Rights Reserved



NOTICE:
 THE INFORMATION CONTAINED HEREON IS THE PROPERTY OF ROYAL GROUP, INC. IT'S CONTENTS ARE CONFIDENTIAL AND MUST NOT BE COPIED OR SUBMITTED TO OUTSIDE PARTIES FOR USE OR EXAMINATION WITHOUT THE WRITTEN PERMISSION OF ROYAL.